

# ES-E1000 Series

## Portable Power Station

### User Manual

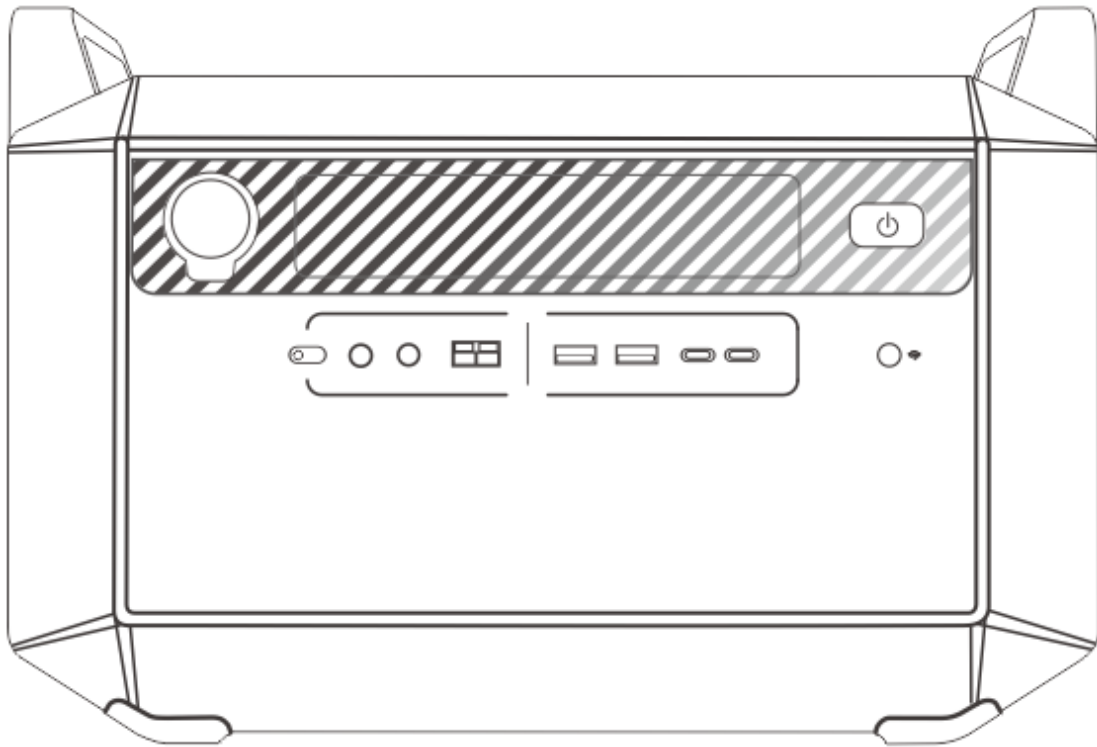

Before using the product,  
please read this manual  
carefully and keep it properly  
for future reference!

**Zhejiang Uniview Technologies Co., Ltd.**

## Notice to Customers

Dear customer, thank you for choosing our products and services. Before using the product, please read this user manual carefully to have a clear understanding based on which you can use the product successfully. Once you use this product, it is considered that you have understood, approved, and accepted all the terms and service contents specified in the user manual. Users shall be responsible for their behavior and the corresponding consequences.

If you do not operate the product correctly, it may cause injury to yourself or others or cause damage to the product and property loss. Users shall be responsible for all the losses arising therefrom. Accordingly, the promised service warranty terms shall automatically lapse.

In compliance with laws and regulations, the company reserves all the rights for final explanation for the documents related to the product. The documents are subject to update, revision, or abrogation without prior notice. The company aims to ensure the accuracy of product functions, features, and other information described in the user manual, but shall not bear the responsibility for any errors, omissions, or minor differences between the user manual and the product.

# Contents

<b>I. Safety Guidelines .....</b>	<b>1</b>
● Safety precautions.....	1
● Disposal .....	2
<b>II. Product Introduction .....</b>	<b>3</b>
1. Product appearance .....	3
2. UI .....	4
3. Specifications.....	5
<b>III. Use of the product .....</b>	<b>7</b>
1. Use of the product .....	7
2. AC charging.....	8
3. Anderson port DC charging.....	9
4. EPS function .....	9
5. Long-term backup power mode.....	10
6. Enhanced overload mode.....	10
7. Automatic identification of power grid system .....	10
<b>IV. Fault Display and Handling .....</b>	<b>11</b>
<b>V. Package Contents .....</b>	<b>14</b>
<b>VI. Maintenance .....</b>	<b>14</b>
<b>VII. Warranty .....</b>	<b>14</b>
<b>Disclaimer and Safety Warnings .....</b>	<b>15</b>

## I. Safety Guidelines

### ● Safety precautions

1. Do not immerse the product into liquid or water, or make it hygroscopic. If there is dirt on the surface or interface of the product, use a dry cloth to clean it.
2. It is strictly forbidden to put the product near a heat source, combustion source, or heating furnace to prevent the hazards because the product becomes overheated.
3. It is prohibited to use the product in an environment with strong static electricity or high magnetic fields. Such situations may cause the product unable to operate properly or the protection function to fail, leading to accidents.
4. Do not disassemble the product, use the lithium-ion cell for other devices, or even connect the cell to a socket. Do not use sharp objects to puncture the product when repairing or welding the battery cell.
5. Do not use unofficial parts or accessories. If you need replacement, please find purchase information through the distribution channels specified by the company.
6. It is forbidden to stack a heavy load that weighs over 30 kg/66 lbs on the product. Avoid metal items such as necklaces, coins, and hairpins while storing the product.
7. The best ambient temperature for the product is 20°C–30°C. If the temperature is too high, it may cause product failure or even permanent damage! If the temperature is too low, it may cause performance degrade or even malfunction. The product can operate properly only after the ambient temperature is recovered to normal.
8. Do not hit or throw the product. Avoid falling, external impact, and strong vibration. Shut down the product immediately in case of strong external impact.
9. If the product accidentally falls into water during use, place it in a safe open area and keep a distance from it till it is completely dry. After the product is dried, do not use it anymore, and dispose of it properly in accordance with the method described in this manual.

10. If the product catches fire by accident, it is recommended that you use extinguishing devices in the following order: sand, fire blanket, dry powder, and carbon dioxide extinguisher.
11. If the product is seriously damaged, do not touch the exposed cell. For safety, place the product in an open area, away from combustibles and people, and then retire it in accordance with local laws and regulations.
12. Do not place the air outlet of the product against the wind or forcibly block the fan when the product is operating. Do not place any objects within 5 cm around the vent, and do not leave the product in an unventilated or dusty environment.
13. Keep the product out of reach of children and pets.
14. Do not carry the product on board an airplane because it contains lithium batteries. In accordance with the international shipping regulations, the lithium batteries carried on board cannot exceed 100 Wh! The battery configuration of the product exceeds the specified limit for boarding.



## ● Disposal

1. When the service life of the product expires or the product fails to be started due to battery over-discharge, the product is not worth for repairing or using any more. Conditions permitting, verify that the product is completely discharged, and then place it in a specified recycling bin for disposal or hand it over to a professional battery recycling agency.
2. If product obsolescence is due to accidental damage or faults of the product and if the battery cannot be completely discharged, contact a professional battery recycling agency instead of directly discarding the battery in a battery recycling bin, which may cause potential safety hazards.

## II. Product Introduction

This product is a portable power station, with a battery capacity of 998 Wh and rated output power of 1000 W. It has built-in high-rate lithium iron phosphate (LFP) power cells with excellent safety.

This product provides the bidirectional inverter function. The AC output is a pure sine wave of voltage, ranging from 110 V to 130 V (50/60 Hz), and the rated output power is 1000 W. Fast charging from the mains is variable-power charging. The maximum input power of 800 W, and it takes about 1.7 hours to complete the 0–100% charging process.

This product provides multiple output ports, including Anderson, DC5521, car charger, USB-A, and USB-C, and charging ports for the mains, car charger, and solar panel.

### 1. Product appearance

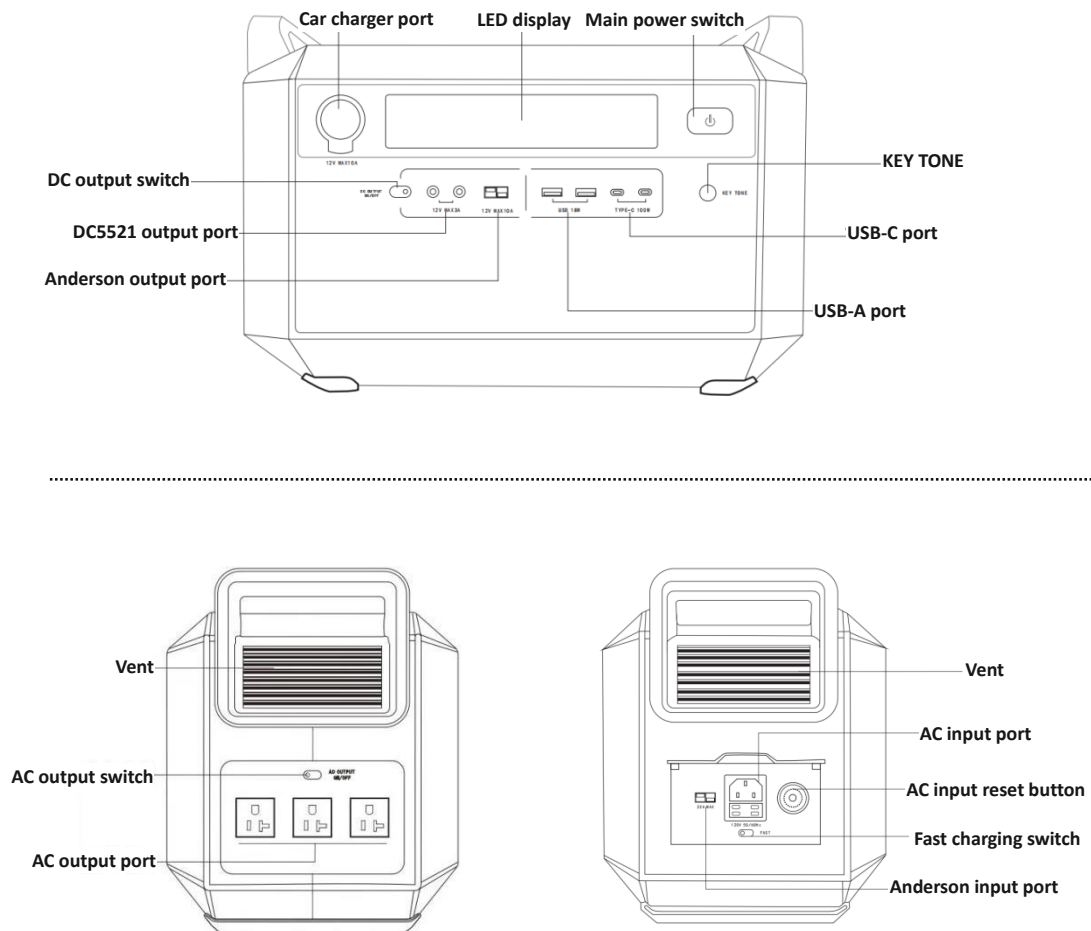

※All the figures in the user manual are for reference only, and the actual product shall prevail.

## 2. UI

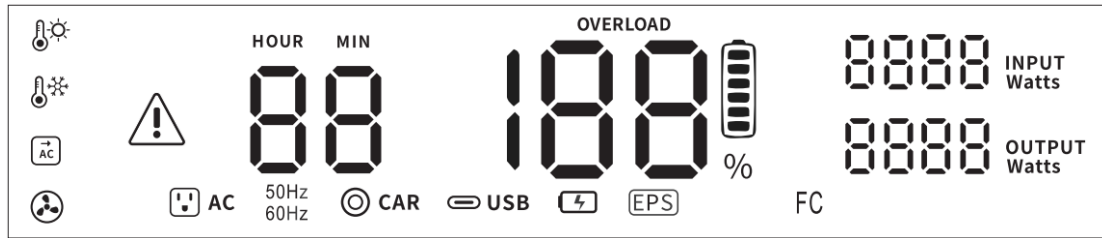

	Alarm		EPS function
	High temperature protection	FC	Charging gear
	Low temperature protection	OVERLOAD	Overload protection
	AC input		Battery percentage
	AC output startup		AC input mode
	Fan operation		Remaining discharging / charging time
	DC output startup		Input power
	USB output startup		Output power

For more information about fault display and handling, refer to Chapter 4.

### 3. Specifications

#### Basic specifications

Net weight	12 kg/26.5 lbs	Size	38.0 × 21.4 × 26.4 cm/15.0 × 8.4 × 10.4 in
Battery capacity	998 Wh (39000 mAh/25.6 V)	Cycle life	4000 times
Rated power	1000 W, peak power of 1800 W	Cell type	Lithium iron phosphate battery
Super-fast charging	Supported	EPS function	Supported
Long-term backup power mode	Supported	Smart car charging mode	Supported
Enhanced overload mode	Supported	Automatic identification of power grid system	Supported
Power bank	Not supported		

#### Output specifications

AC output (× 3)	Pure sine wave 120 V 50/60 Hz	
USB-A output (× 2)	5V/3A, 9V/2A, 12V/1.5A, maximum output of 18 W	
USB-C output (× 2)	(5/9/12/15 V)3A, 20 V/5 A, maximum output of 100 W	
Anderson output port	13 V/10 A	The maximum current for power sharing by the Anderson port, car charger port, and DC5521 port is 10 A.
Car charger port	13 V/10 A	
DC5521 output port (× 2)	13 V/3 A	
EPS function description	The startup time is less than 30 ms, and standby emergency power supply is supported.	

#### Input specifications

AC input	Variable charging power 800 W (Max). 1.7 hours for 0–100% charging.
Anderson port	18 V to 20 V, 22 A, maximum input of 400 W.
Anderson port (car charger input)	13.2 V/8 A



## Use conditions

Operating temperature	-10°C to 45°C (14°F to 113°F)
Charging temperature	0°C to 40°C (32°F to 104°F)
Working environment humidity	20% to 90% RH (no condensation)
Storage temperature	-10°C to 45°C (14°F to 113°F)
Storage environment humidity	< 70% RH (no condensation)
Operating altitude	< 2000 m

---

※ The product performance may vary with the actual environmental factors, and the performance data may change accordingly. Performance will change. The actual situation shall prevail.

## III. Use of the product

### 1. Use of the product

#### Power-on/off

The main power switch controls the product to power on or power off.

- 1 Press the main power switch to power on the product.
- 2 In power-on state, long-press the main power switch for 2 seconds to power off the product.
- 3 In power-on state, press the main power switch to make the display switch between on and off states.

After the product is powered on, the display is turned on. If no operation is performed within 3 minutes, the display will be turned off automatically. In this case, you can press the main power switch to turn on the display. In power-on state, you can press the main power switch to make the display switch between on and off states. After you press the main power switch to power off the product, the USB power supply, 12 V DC power supply, and AC power supply are all turned off. When all output switch are off and nothing is operated, it will turn off automatically after 2 hours.

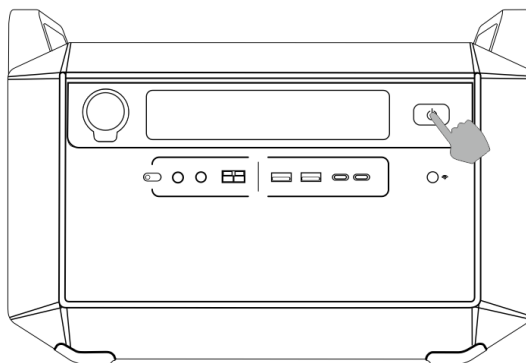

#### DC and USB output

- 1 Turn on the main power supply.
- 2 Press the DC output switch. After that, the 12 V DC output ports (including the car charger port, DC5521 port, and Anderson port) start to output power supply, and the USB is also turned on. The DC switch indicator is turned on at the same time.
- 3 Press the DC output switch again. After that, the DC output is turned off, and the 12 V DC and USB switch indicators are turned off. When the output of each 12 V DC port is less than 3 W for 12 hours continuously, the DC output switch will turn off automatically.

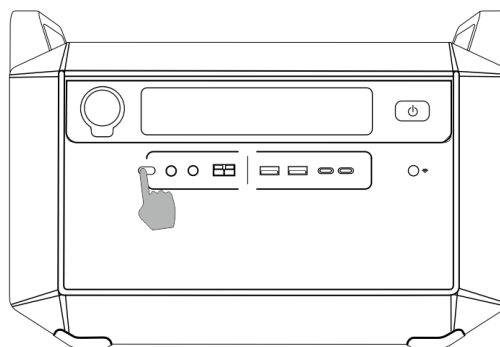

## AC output

- 1 Turn on the main power supply.
- 2 Press the AC output switch. After that, the 120 V AC output is turned on, the AC socket starts to output power supply, and the AC switch indicator is turned on.
- 3 Press the AC output switch again. After that, the 120 V AC output is turned off, and the AC output switch indicator is turned off. When the output of AC port is less than 15 W for 12 hours continuously, the AC output switch will turn off automatically.

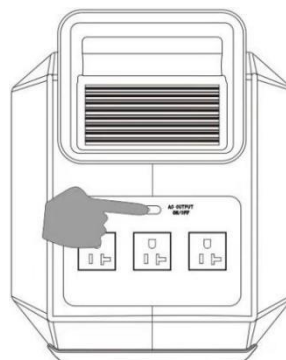

You can press the AC output switch during AC charging to turn on the AC output to enter the EPS mode, and then the AC socket can take power supply directly from the AC input port. In this case, the power of charging and 120 V AC output cannot exceed the limit power of AC input (peak value < 1200 W); otherwise, the AC input may be disconnected for protection. In EPS mode, when the AC output power exceeds 850 W, the AC input cannot power the battery, and meanwhile the maximum AC output power is 950 W. In EPS mode, once the power supply fails due to abnormal AC input, the product immediately switches to battery power supply within 30 ms.

During DC charging, the 120 V AC can still output power supply normally, that is, charging and discharging can be performed simultaneously.

## 2. AC charging

After the AC input charging port is connected to the mains:

1. In power-off state, the product wakes up automatically and charges the battery in accordance with the preset charging power.
2. When the 120 V AC output is operating properly, it will switch to EPS mode for power supply and start charging the battery at approximately 250 W.

You can press the fast charging switch to cycle between low-rate charging and fast charging of AC input. After the power supply is turned on, low-rate charging is performed by default.

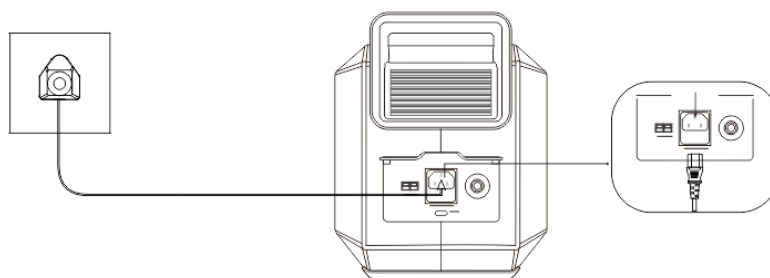

**Note:** When the AC input is connected to the mains, if you do not need to use the AC output, please turn off the AC output switch, otherwise it will reduce the AC charging power.

For the AC charging indicators, refer to the following table.

Pressing sequence	Screen display	Variable charging power	Full charging time
Default	/	≤ 400 W	≈ 3.1 h
First time	FC	≤ 800 W	≈ 1.7 h
Second time	/	≤ 400 W	≈ 3.1 h

### 3. Anderson port DC charging

After the DC input charging port is connected to a car charger or a solar panel:

- 1 In power-off state, the product automatically wakes up and starts charging.
- 2 In power-on state, the product supports charging and discharging simultaneously.

**Note:**

In smart car charging mode, if the car engine is not working, car charging is not performed so as to protect the 12 V battery. Car charging can be performed normally only after the car engine starts working.

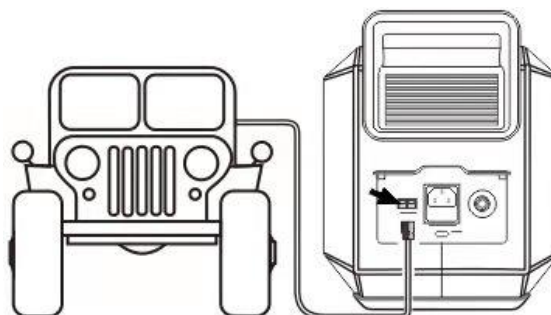

This product supports the same type of solar panels. The company shall not bear the responsibility for any damage caused by improper operations or using different types of solar panels.

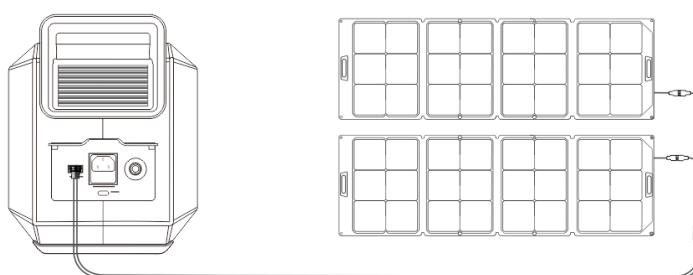

### 4. EPS function

This mode is enabled by default. In EPS mode, AC output is used, which preferentially gets power supply from AC input, and the battery is in standby mode.

After the 120 V AC output is started, the AC input is connected to the mains, the AC socket switches to the mains, and the battery is in standby mode.

When the AC input is connected to the mains, if you press the AC switch to start the 120 V AC output, the AC socket will directly take power supply from the mains.

When the AC input is abnormal and fails to supply power, the product immediately switches to battery power supply within 30 ms to maintain normal 120 V AC output.

**Note:**

The power supply in EPS mode involves switching time and cannot replace professional UPS products. When using EPS mode, you need to confirm whether the power demands of electrical appliances are satisfied.

To use the EPS function, ensure that the load does not exceed the rated power. The EPS function may fail to start when the rated power is exceeded.

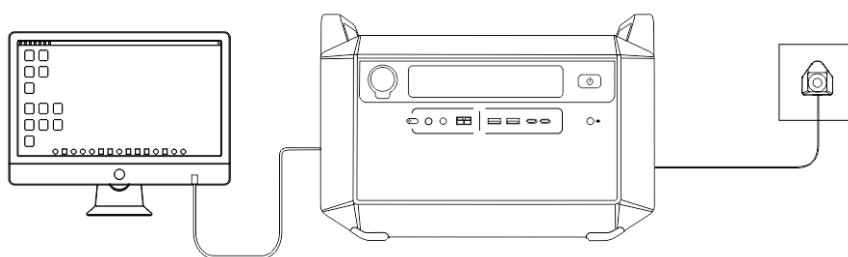

## 5. Long-term backup power mode

The product can be connected to the mains for a long period of time. The built-in intelligent system of the product automatically manages charging and discharging. If the product is not used for a long period of time, to meet the power backup requirement, the AC input port can always be connected to the mains, and it is intelligently determined that the battery is automatically recharged every 45 days. This mode is enabled by default.









## 6. Enhanced overload mode





For the load requirements, when a load exceeds the rated AC output power of the product, UPS protection is performed to output power supply for the load. In this case, the output power is limited to the maximum output power. The actual loads that can be supported depend on the load types. This mode is enabled by default.

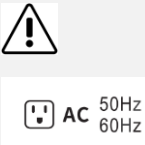

## 7. Automatic identification of power grid system

The power grid system is automatically identified in accordance with the frequency of mains charging. When the AC output is turned on the next time, the product automatically switches to the voltage mode corresponding to the mains. This mode is enabled by default.

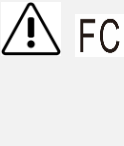
## IV. Fault Display and Handling

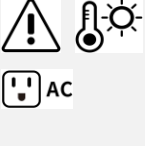
Warning icon	Fault type	Handling	Remarks
 <b>OVERLOAD</b>  AC 50Hz 60Hz	Flashing: The rated power is exceeded but no protection is performed. If the indicator is solid on, it indicates overload protection.	The load exceeds the load capacity of the product. 1. When the fault occurs, press the AC output switch to clear the alarm. 2. Reduce the load to make the product have a load within the load capacity range so that it can operate properly.	AC output termination and overload protection.
 	The fan is faulty or blocked.	The fan fails to operate properly. 1. Check whether the fan fails to operate due to being blocked by a foreign object. If yes, remove the foreign object to make the fan operate properly. 2. If the fan is not blocked by any foreign object, it is recommended that you replace the faulty fan and send it for repair.	Output termination.
 	The battery is faulty, and BMS protection is performed.	If the battery level is 0, charge the battery in time to clear the alarm.	Output termination.
  <b>CAR</b>	The DC power supply is faulty, and the output is abnormal.	Check whether the load capacity of the product is exceeded. 1. When the fault occurs, press the DC output switch to clear the alarm. 2. If the alarm indicates that the load capacity of the product is exceeded, reduce the load and press the DC output switch again to make the product operate properly.	DC output termination.

	<p>The USB power supply is faulty, and the output is abnormal.</p>	<p>Check whether the load capacity of the product is exceeded.</p> <ol style="list-style-type: none"> <li>1. When the fault occurs, press the USB output switch to clear the alarm.</li> <li>2. If the alarm indicates that the load capacity of the product is exceeded, reduce the load and press the USB output switch again to make the product operate properly.</li> </ol>	<p>USB output termination.</p>
	<p>The AC power supply is faulty, and the output is abnormal.</p>	<p>The AC power supply fails under a special load.</p> <ol style="list-style-type: none"> <li>1. Press the AC output switch to clear the alarm.</li> <li>2. Verify that the load is not a special load before using the product again. For some loads, the power differs greatly between cold state and hot state.</li> </ol>	<p>AC output termination.</p>
	<p>The AC charging is abnormal, and the input is abnormal.</p>	<p>The fault is generally caused because the input AC voltage is out of the range. Verify that the AC voltage is within the normal range.</p>	<p>AC input termination.</p>
	<p>The DC charging is abnormal, and the input is abnormal.</p>	<p>The fault is generally caused because the input DC voltage is out of the range. Verify that the DC voltage is within the normal range.</p>	<p>DC input termination.</p>
	<p>If the two indicators flash at the same time, it indicates a temperature alarm of the battery BMS.</p>	<p>It is detected that the battery temperature is too high. Wait the temperature to change to normal before using the product again.</p>	<p>Output termination.</p>
	<p>If the two indicators flash at the same time, it indicates a temperature alarm of the power device.</p>	<p>It is detected that the power device temperature is too high. Wait the temperature to change to normal before using the product again.</p>	<p>Output termination.</p>

	<p>If the two indicators flash at the same time, it indicates a low temperature alarm of the power device.</p>	<p>It is detected that the power device temperature is too low. Wait the temperature to change to normal before using the product again.</p>	<p>Output termination.</p>
	<p>If the two indicators flash at the same time, it indicates a low temperature alarm of the battery BMS.</p>	<p>It is detected that the battery temperature is too low. Wait the temperature to change to normal before using the product again.</p>	<p>Output termination.</p>

**Tip:** During the product operation, if any of the above warning icons appears and if the icon persists flashing after the product is restarted or the environment is improved, stop using the product immediately and confirm the fault type. If you cannot handle the problem, contact customer service for technical support. It is forbidden to disassemble the product by yourself! When the product is in high-power output state, heat is generated inside, and the product automatically turns on the fan to dissipate heat. It is normal there is a slight noise.



## V. Package Contents

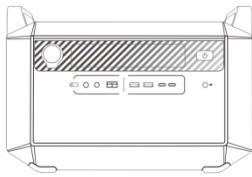

Power station

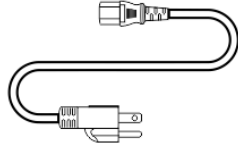

AC charging cable

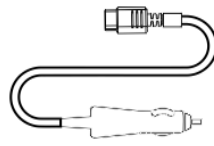

Car charging cable

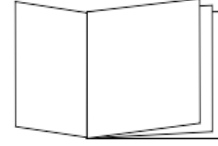

User manual

## VI. Maintenance

1. It is recommended that the product be in long-term backup power mode. If the product needs to be stored for a long period of time, charge and discharge it once every three months (that is, first discharge the product to 30% of the full capacity, and then charge the product to 60%.)
2. To ensure the service life of the product and safety, do not store this product in an environment with an ambient temperature higher than 45°C or lower than -10°C for a long period of time.
3. To extend the service life of the battery, it is recommended that this product be used in an environment with an ambient temperature between 20°C and 30°C, and be kept away from water sources, heat sources, and other conductive objects.
4. If the battery level is less than 1% after use, charge the battery to 60% of the full capacity before storage. If the product is left idle for a long period of time with the battery in seriously low condition, it may cause irreversible damage to the battery cell and may shorten the service life of the product.
5. If the battery level of the product is seriously insufficient while the product idle time is too long, the product will enter deep sleep mode. The product can be used again only after being charged.

## VII. Warranty

1. This product is guaranteed for 24 months under normal operating conditions from the date of purchase.
2. Please pack and transport the products to be repaired properly. The company shall not be responsible for any damage or loss during transportation.
3. During the free-of-charge warranty period, the company reserves the right to refuse

providing services or charge the cost of parts and services in the following circumstances:

1. The appearance of the product is damaged after use.
  2. Unauthorized disassembly and maintenance of non-professionals.
  3. Performance problems caused by human factors.
  4. Damage caused by natural disasters, lightning strikes, accidents, and other irresistible factors.
4. Please read the instruction carefully before use.

## Disclaimer and Safety Warnings

### Battery Use Caution

- When battery is used, avoid:
  - Extremely high or low temperature and air pressure during use, storage and transportation.
  - Battery replacement.
- Use the battery properly. Improper use of the battery such as the following may cause risks of fire, explosion or leakage of flammable liquid or gas.
  - Replace battery with an incorrect type;
  - Dispose of a battery into fire or a hot oven, or mechanically crushing or cutting of a battery;
- Dispose of the used battery according to your local regulations or the battery manufacturer's instructions.

### Avertissement de l'utilisation de la batterie

- Lorsque utiliser la batterie, évitez:
  - Température et pression d'air extrêmement élevées ou basses pendant l'utilisation, le stockage et le transport.
  - Remplacement de la batterie.
- Utilisez la batterie correctement. Mauvaise utilisation de la batterie comme celles mentionnées ici, peut entraîner des risques d'incendie, d'explosion ou de fuite liquide de gaz inflammables.
  - Remplacer la batterie par un type incorrect;
  - Disposer d'une batterie dans le feu ou un four chaud, écraser mécaniquement ou couper la batterie;
- Disposer la batterie utilisée conformément à vos règlements locaux ou aux instructions du fabricant de la batterie.

### Regulatory Compliance

#### FCC Statements

This device complies with Part 15 of the FCC Rules. Operation is subject to the following two conditions: (1) this device may not cause harmful interference, and (2) this device must accept any interference received, including interference that may cause undesired operation.

Visit [http://en.uniview.com/Support/Download\\_Center/Product\\_Installation/Declaration/](http://en.uniview.com/Support/Download_Center/Product_Installation/Declaration/) for

SDoC.

**Caution:** The user is cautioned that changes or modifications not expressly approved by the party responsible for compliance could void the user's authority to operate the equipment.

**NOTE:** This equipment has been tested and found to comply with the limits for a Class A digital device, pursuant to part 15 of the FCC Rules. These limits are designed to provide reasonable protection against harmful interference when the equipment is operated in a commercial environment. This equipment generates, uses, and can radiate radio frequency energy and, if not installed and used in accordance with the instruction manual, may cause harmful interference to radio communications. Operation of this equipment in a residential area is likely to cause harmful interference in which case the user will be required to correct the interference at his own expense.

LVD/EMC Directive



This product complies with the European Low Voltage Directive 2014/35/EU and EMC Directive 2014/30/EU.

WEEE Directive–2012/19/EU



The product this manual refers to is covered by the Waste Electrical & Electronic Equipment (WEEE) Directive and must be disposed of in a responsible manner.

Battery Directive-2013/56/EC



Battery in the product complies with the European Battery Directive 2013/56/EC. For proper recycling, return the battery to your supplier or to a designated collection point.

## **INSTRUCTIONS PERTAINING TO RISK OF FIRE, ELECTRIC SHOCK, OR INJURY TO PERSONS**

### **IMPORTANT SAFETY INSTRUCTIONS**

- a) Read all the instructions before using the product.
- b) To reduce the risk of injury, close supervision is necessary when the product is used near children.
- c) Do not put fingers or hands into the product.
- d) Use of an attachment not recommended or sold by power pack manufacturer may result in a risk of fire, electric shock, or injury to persons.
- e) To reduce risk of damage to the electric plug and cord, pull the plug rather than the cord when disconnecting the power pack.
- f) Do not use a battery pack or appliance that is damaged or modified. Damaged or modified batteries may exhibit unpredictable behavior resulting in fire, explosion or risk of injury.
- g) Do not operate the power pack with a damaged cord or plug, or a damaged output cable.
- h) Do not disassemble the power pack, take it to a qualified service person when service or repair is required. Incorrect reassembly may result in a risk of fire or electric shock.
- i) To reduce the risk of electric shock, unplug the power pack from the outlet before attempting any instructed servicing.
- j) PERSONAL PRECAUTIONS

1. Have plenty of fresh water and soap nearby in case battery acid contacts skin, clothing, or eyes.
  2. Wear complete eye protection and clothing protection. Avoid touching eyes while working near battery.
  3. If battery acid contacts skin or clothing, wash immediately with soap and water. If acid enters eye, immediately flood eye with running cold water for at least 10 minutes and get medical attention immediately.
  4. NEVER smoke or allow a spark or flame in vicinity of battery or engine.
  5. Be extra cautious to reduce risk of dropping a metal tool onto battery. It might spark or short-circuit battery or other electrical part that may cause explosion.
- k) When charging the internal battery, work in a well ventilated area and do not restrict ventilation in any way.
- l) Under abusive conditions, liquid may be ejected from the battery; avoid contact. If contact accidentally occurs, flush with water. If liquid contacts eyes, additionally seek medical help. Liquid ejected from the battery may cause irritation or burns.
- m) Do not expose a power pack to fire or excessive temperature. Exposure to fire or temperature above 130°C may cause explosion. The temperature of 130°C can be replaced by the temperature of 265°F.
- n) Have servicing performed by a qualified repair person using only identical replacement parts. This will ensure that the safety of the product is maintained.

#### INSTRUCTIONS RELATIVES AUX RISQUES D'INCENDIE, DE CHOC ÉLECTRIQUE OU DE BLESSURES CORPORELLES

##### INSTRUCTIONS DE SÉCURITÉ IMPORTANTES

- a) Veuillez lire toutes les instructions avant l'utilisation de ce produit.
- b) Afin de réduire le risque de blessure, veuillez assurer une surveillance étroite quand ce produit est utilisé à proximité d'enfants.
- c) Ne pas mettre les doigts ou les mains dans ce produit.
- d) L'utilisation d'un accessoire non recommandé ou vendu par le fabricant de ce produit peut causer un risque d'incendie, de choc électrique ou de blessures.
- e) Veuillez tirer sur la fiche plutôt que sur le cordon lors de la déconnexion de la prise de courant dans le but de réduire le risque d'endommager la fiche et le cordon électriques.
- f) Ne pas utiliser un bloc-batterie ou un appareil endommagé ou modifié. Les batteries endommagées ou modifiées peuvent conduire à un incendie, une explosion ou un risque de blessure.
- g) Ne pas utiliser ce produit si son cordon ou fiche, ou câble de sortie est endommagé(s).
- h) Ne pas désassembler ce produit. Veuillez recourir à un technicien qualifié en cas d'entretien ou de réparation. Un ré-assemblage incorrect peut causer un risque d'incendie ou de choc électrique.
- i) Dans le but de réduire le risque de choc électrique, veuillez retirer ce produit de la prise de courant avant d'effectuer toute opération d'entretien.
- j) PRÉCAUTIONS DE SÉCURITÉ PERSONNELLES
  1. Pour éviter le cas où l'acide de la batterie entrerait en contact avec la peau, les vêtements ou les yeux, veuillez préparer une grande quantité d'eau fraîche et de savon à proximité.

2. Veuillez porter un équipement de protection complète pour yeux et vêtements. Veuillez éviter le contact avec les yeux, quand vous travaillez à proximité de ce produit.
  3. Si l'acide de la batterie entre en contact avec la peau ou les vêtements, veuillez les laver immédiatement à l'eau et au savon. Si l'acide pénètre dans les yeux, veuillez rincer les yeux immédiatement avec de l'eau froide abondante et courante pendant au moins 10 minutes et consulter immédiatement un médecin.
  4. Ne JAMAIS fumer ou laisser une étincelle ou une flamme à proximité de la batterie ou du moteur.
  5. Soyez très prudent afin de réduire le risque de chute d'un outil métallique sur la batterie. Sinon, cela pourrait causer une étincelle ou un court-circuit de la batterie ou d'une autre pièce électrique, voire une explosion.
- k) Lors de la charge de la batterie interne, veuillez faire fonctionner ce produit dans un endroit bien ventilé et ne pas limiter la ventilation de quelque manière que ce soit.
- l) Dans des conditions abusives, un liquide peut être éjecté de la batterie. Veuillez éviter tout contact. En cas de contact accidentel, veuillez rincer la partie à l'eau. Si le liquide entre en contact avec les yeux, veuillez consulter un médecin. Le liquide éjecté de la batterie peut causer des irritations ou des brûlures.
- m) Ne pas exposer ce produit au feu ou à une température excessive. L'exposition au feu ou à une température supérieure à 130°C ( 265°F) peut causer une explosion.
- n) Si une réparation est nécessaire, veuillez recourir à un réparateur qualifié et utiliser des pièces de rechange identiques. Cela permettra de garantir le maintien de la sécurité du produit.

#### **User Maintenance Instructions**

1. Please turn off all power buttons after use.
2. Do not use gasoline, volatile oil, thinner or kerosene to clean the product.
3. Do not use hard or sharp objects to hit this product.
4. Do not connect this product to appliances that exceed the rated power of the product.
5. Do not leave this product with low battery for a long time.
6. Do not leave this product at full load for a long time.
7. Do not discharge this product while charging.
8. Please handle gently when using this product.
9. Please plug the plugs into the interfaces in vertically, do not shake up and down.

#### **Instructions de maintenance pour l'utilisateur**

1. Veuillez éteindre tous les boutons d'alimentation après l'utilisation.
2. Ne pas nettoyer ce produit avec de l'essence, de l'huile volatile, du diluant ou du kérosène.
3. Ne pas frapper ce produit avec des objets durs ou pointus.
4. Ne pas connecter ce produit à des appareils au-delà de la puissance nominale du produit.
5. Ne pas laisser ce produit avec une batterie faible pendant une longue période.
6. Ne pas laisser ce produit à pleine charge pendant une longue période.
7. Ne pas décharger ce produit au cours de la charge.
8. Veuillez manipuler doucement ce produit lors de l'utilisation.
9. Veuillez brancher les fiches dans les ports verticalement. Ne pas secouer de haut en bas.

### **Moving and Storage Instructions**

1. Please fully charge the battery before storing the product.
2. Do not store this product in humid, high-temperature, hypersaline, dusty, or strong magnetic field environments for a long time.
3. Do not drop this product or store it in a bumpy environment for a long time.
4. Do not expose the product to direct sunlight for a long time.
5. Do not let any liquid enter the product.
6. Running a discharge/charge cycle is recommended at least once every three months. (Fully discharge the product and come with a subsequent recharge.)
7. Please avoid overcharge and over-discharge.
8. It is recommended to recharge the product in time when the battery is low.

### Instructions de déplacement et de stockage

1. Veuillez charger complètement la batterie avant le stockage.
2. Ne pas stocker ce produit dans un environnement humide, à haute température, hypersalin, poussiéreux ou à fort champ magnétique pendant une longue période.
3. Ne pas laisser tomber ce produit et ne pas le stocker dans un environnement cahoteux pendant une longue période.
4. Ne pas exposer ce produit à la lumière directe du soleil pendant une longue période.
5. Ne laissez pas de liquide pénétrer dans ce produit.
6. Il vaut mieux effectuer un cycle de décharge/charge au moins une fois tous les trois mois. (Veuillez décharger complètement le produit et puis le recharger).
7. Veuillez éviter les surcharges et les décharges excessives.
8. Quand la batterie est faible, veuillez recharger le produit à temps.